

RAMP KIT 2 CORNER

Height: 3,6 - 9,1 cm

Width: 50 cm

Depth: 50 cm

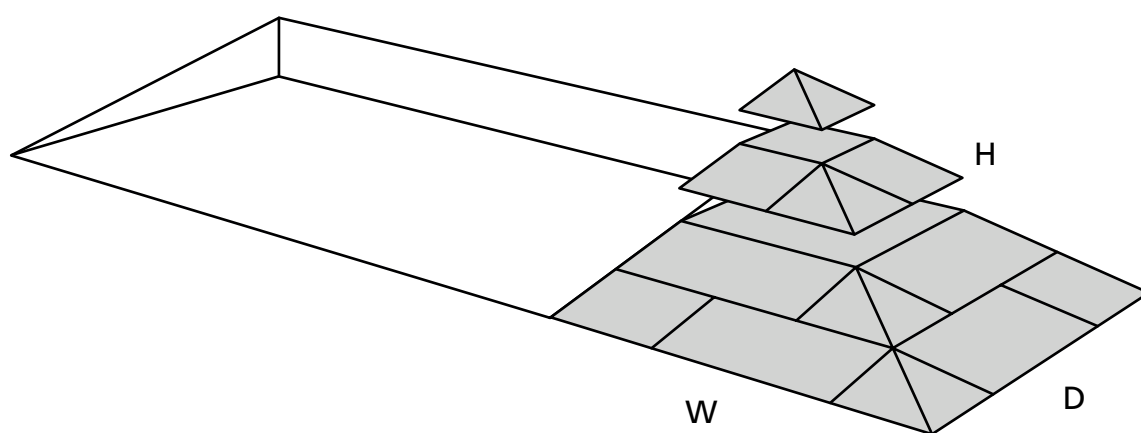

Included

11 x



10 x



1 x

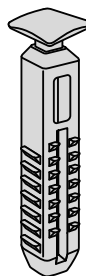

1 x

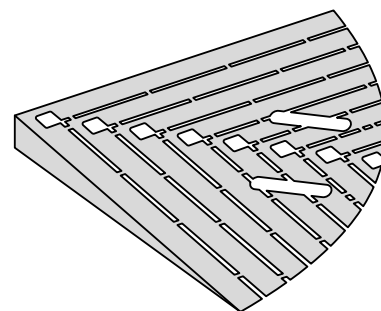

Danish Design Pat. Pend. and produced
in Denmark by Excellent Systems A/S

MOUNTING OF C-LOCKS ON THE RAMP

To connect a corner to a ramp, you have to mount c-locks in the ramp. If the ramp is already installed, you will have to remove the two upper layers.

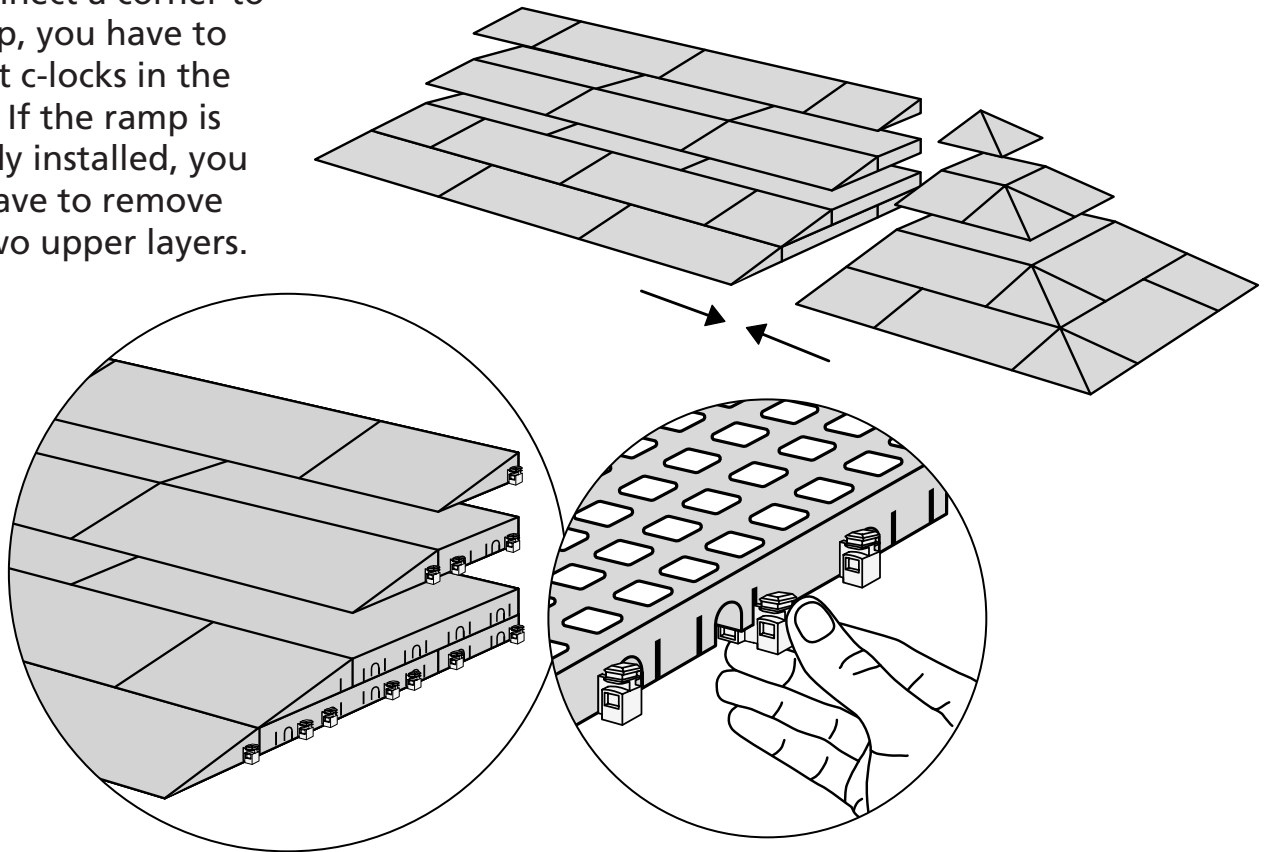

CORNER RAMP ADJUSTER

Is Ramp Adjusters used/needed in the installation, be aware that the ramp and the corner gain the same height.

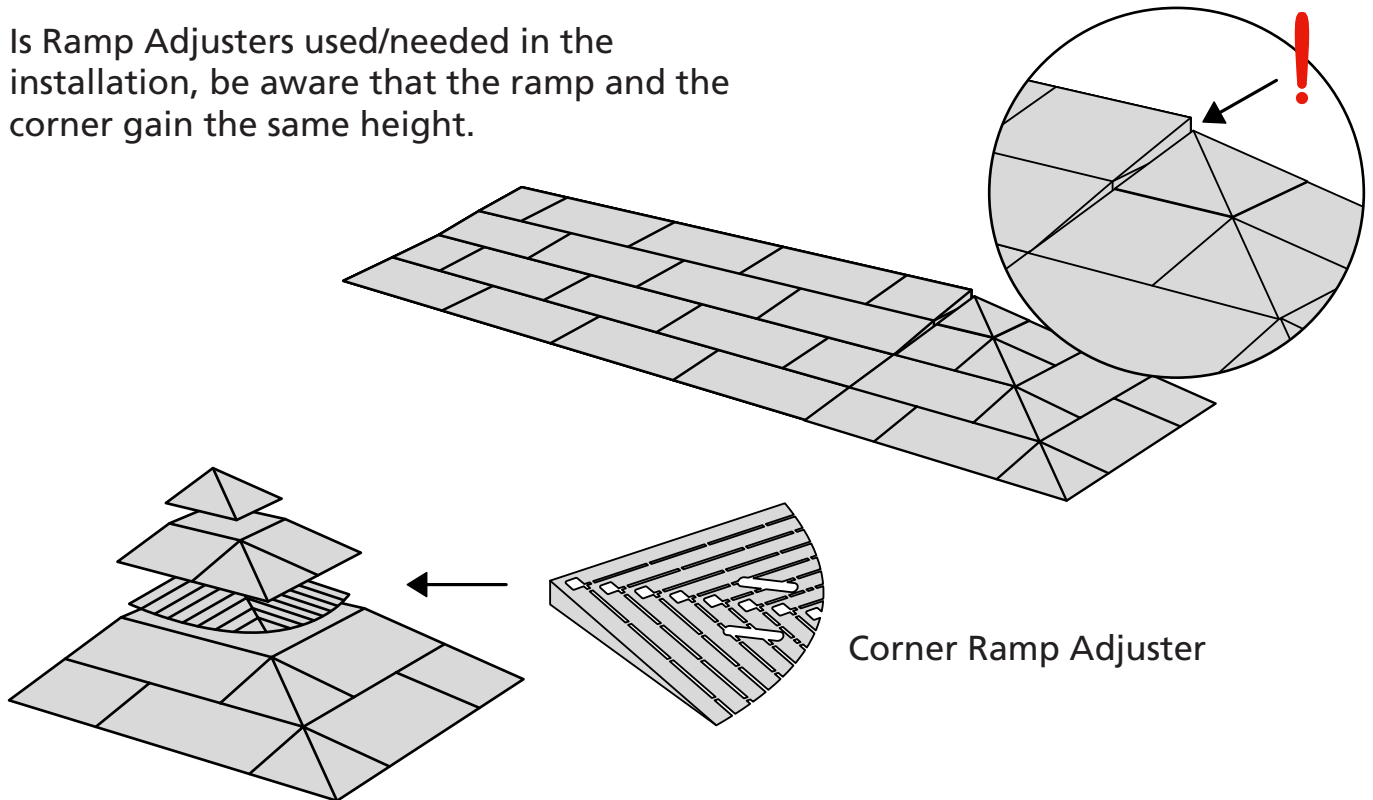

Corner Ramp Adjuster height adjustments:

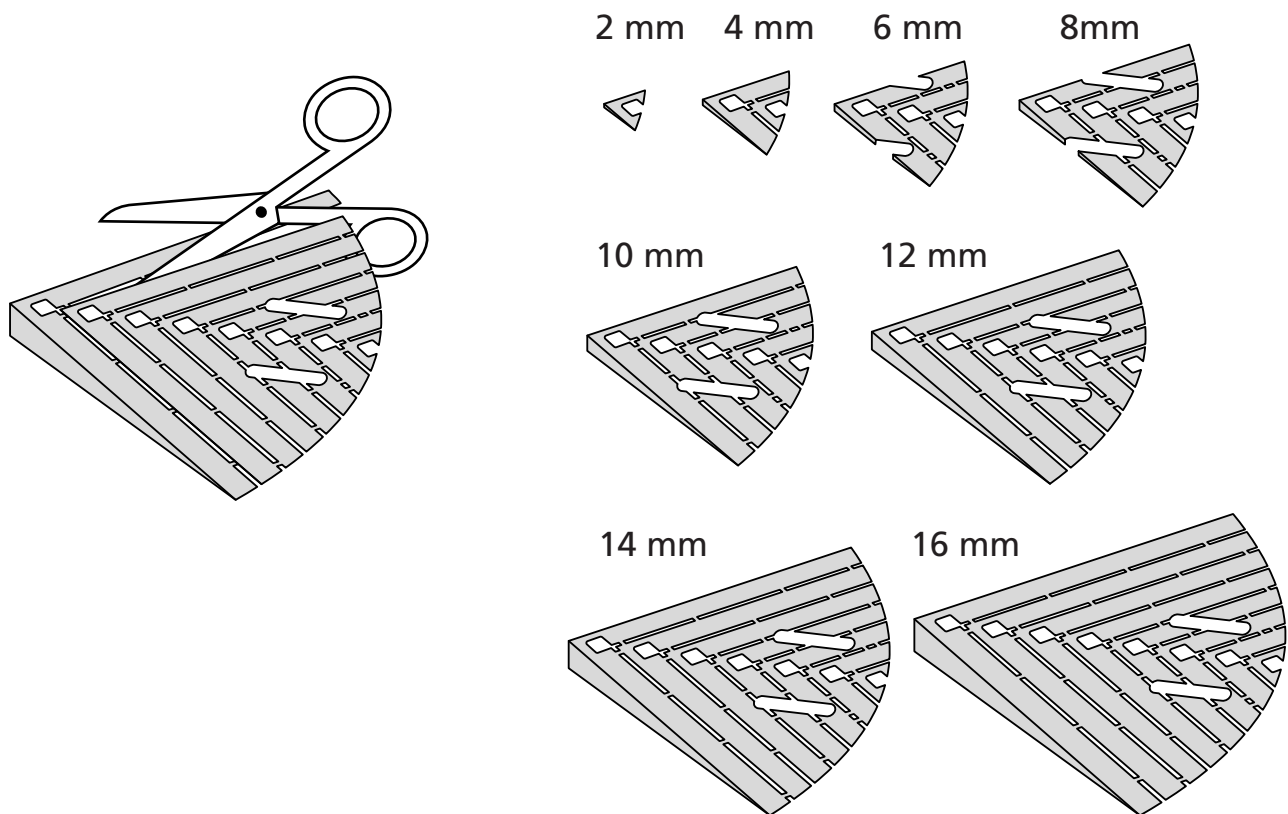

MOUNTING WITH LOCKS

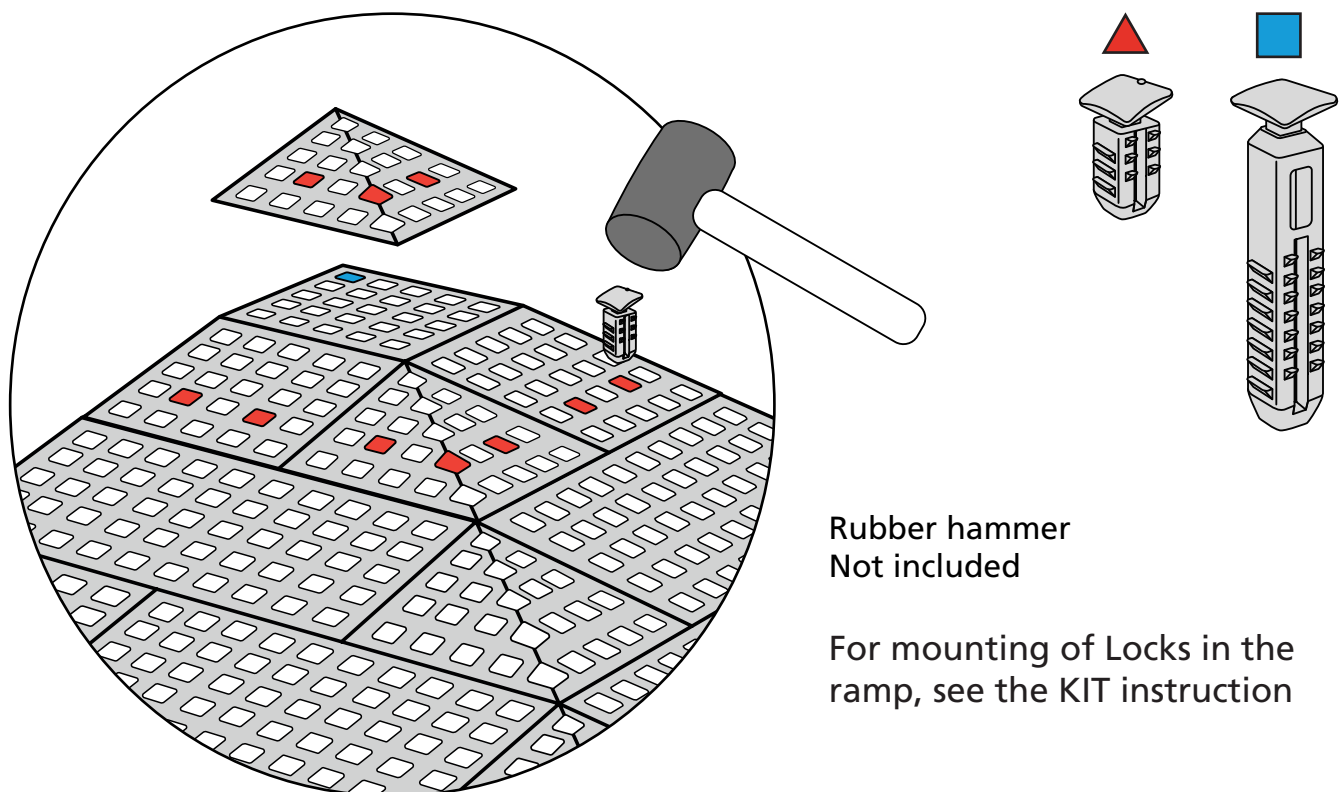

FASTENING WITH MOUNTING PADS

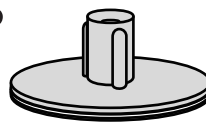

Same instruction as for Ramp KITS.

Indoor:

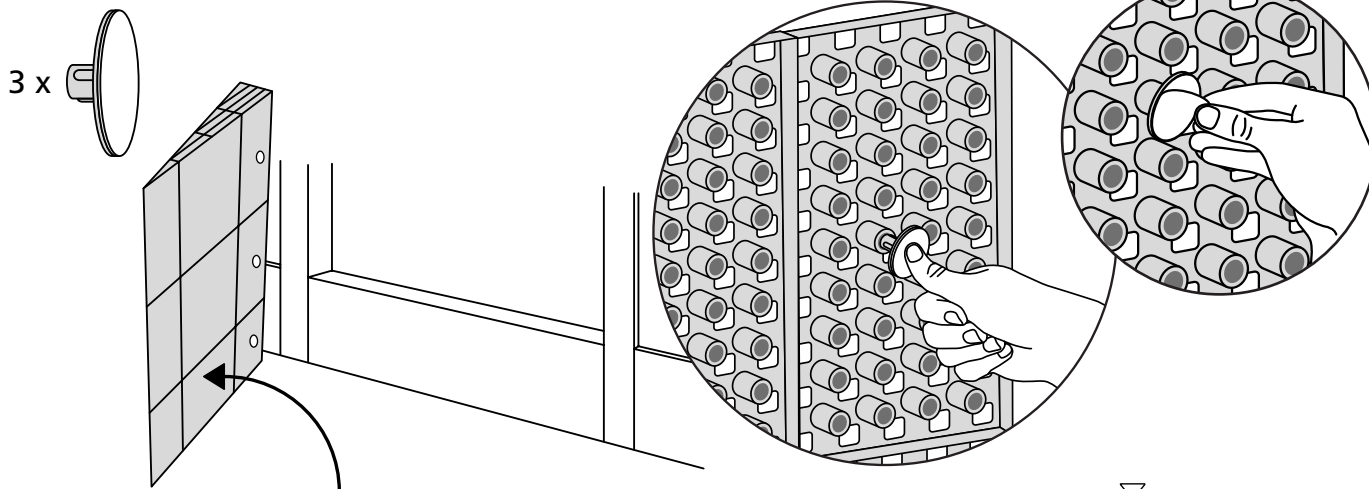

Outdoor:

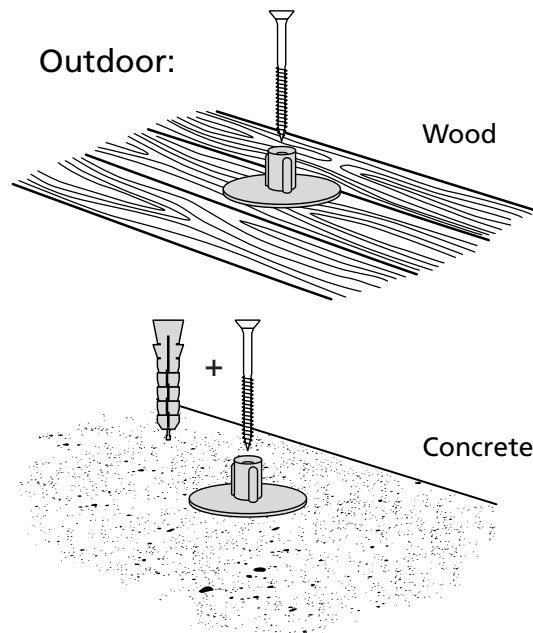
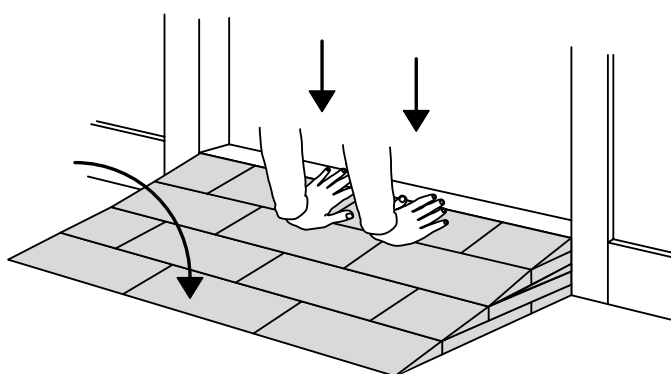

FASTENING WITH STOPPERS

